



RDF300, RDF300.02, RDF340
RDF600



RDF400.01
RDF600T

Flush-mounted room thermostats

RDF300...
RDF340
RDF400...
RDF600...

for 2-pipe, 2-pipe with el. heater and 4-pipe fan coil units
for use with compressors in DX type equipment

- **RDF300 / RDF400 / RDF600/RDF600T:**
AC 230 V operating voltage, on/off or 3-position control outputs
- **RDF340...:**AC 24 V, operating voltage, DC 0...10 V control outputs
- Output for 3-speed or 1-speed fan
- 2 multifunctional inputs for keycard contact, external sensor, etc.
- Operating modes: Comfort, Economy and Protection
- Automatic or manual fan speed control
- Automatic or manual heating/cooling changeover
- Adjustable commissioning and control parameters
- Minimum and maximum setpoint limitation
- User and parameter settings can be retained or restored with power loss

Additional features

- Backlit LCD (RDF300.02, RDF400.01, RDF600, RDF600T)
- Infrared remote control receiver (RDF400.01, RDF600T)
- Auto Timer mode with 8 programmable timers (RDF400.01, RDF600T)

Type of mounting / suitable conduit boxes

- RDF600... for round CEE box, with min 60 mm diameter, min 40 mm depth
- RDF3... / RDF400... for recessed square box with 60.3 mm fixing centers

Use

Applications

To control the room temperature in individual rooms and zones that are:

- Heated or cooled with 2-pipe fan coil units
- Heated or cooled with 2-pipe fan coil units with electrical heater
- Heated and cooled with 4-pipe fan coil units
- Heated or cooled with compressor in DX type equipment
- Heated or cooled with compressor in DX type equipment with electrical heater
- Heated and cooled with compressor in DX type equipment

The RDF300... / RDF400... / RDF600... control:

- One 1- or 3-speed fan
- One or 2 on/off valve actuators
- One on/off valve actuator and one 1-stage electrical heater
- One 3-position valve actuator
- One 1-stage compressor in DX type equipment or one 1-stage compressor with electrical heater

The RDF340... controls:

- One 1- or 3-speed fan
- One or 2 DC 0...10 V valve actuators
- One DC 0...10 V valve actuator and one modulating electrical heater (DC 0...10 V)

Used in systems with:

- Heating or cooling mode
- Automatic heating/cooling changeover
- Manual heating/cooling changeover
- Heating and cooling mode (e.g. 4-pipe system)

Functions

- Maintain room temperature via built-in temperature sensor or external room temperature / return air temperature sensor
- Automatic or manual changeover between heating and cooling mode
- Select applications via DIP switches
- Select operating mode via the operating mode button on the thermostat
- 1- or 3-speed fan control (automatic or manual)
- Display current room temperature or setpoint in °C and/or °F
- Minimum and maximum setpoint limitation
- Key lock (automatic and manual)
- 2 multifunctional inputs, freely selectable for:
 - Operating mode switchover contact (key card)
 - Automatic heating/cooling changeover sensor
 - External room temperature or return air temperature sensor
 - Dewpoint sensor
 - Electrical heater enable
 - Alarm input
- Advanced fan control function, i.e. fan kick, fan start, selectable fan operation (enable, disable or depending on heating or cooling mode)
- Purge function together with 2-port valve in a 2-pipe changeover system
- Reminder to clean filters
- Floor heating temperature limit
- Reload factory settings for commissioning and control parameters
- 7-day time program: 8 programmable timers to switch over between Comfort and Economy mode (RDF400.01 / RDF600T)
- Backlit LCD (RDF300.02 / RDF400.01 / RDF600 / RDF600T)
- Optional infrared remote control (RDF400.01 / RDF600T)









The thermostat supports the following applications, which can be configured by DIP switches on the inner side of the thermostat's front. Depending on the type, on/off or modulating control outputs are available.

Applications for fan coil systems

Application and output signal, DIP switches, diagram	
<ul style="list-style-type: none"> • 2-pipe fan coil unit ON/OFF (heating or cooling) • 2-pipe fan coil unit modulating, DC 0...10 V (heating or cooling) 	<ul style="list-style-type: none"> RDF300... RDF400... RDF600... RDF340
<ul style="list-style-type: none"> • 2-pipe fan coil unit ON/OFF (heating or cooling) with electrical heater • 2-pipe fan coil unit modulating, DC 0...10 V (heating or cooling) with electrical heater 	<ul style="list-style-type: none"> RDF300... RDF400... RDF600... RDF340
<ul style="list-style-type: none"> • 2-pipe fan coil unit modulating, 3-position (heating or cooling) 	<ul style="list-style-type: none"> RDF300... RDF400... RDF600... RDF340
<ul style="list-style-type: none"> • 4-pipe fan coil unit ON/OFF (heating and cooling) 	<ul style="list-style-type: none"> RDF300... RDF400... RDF600... RDF340

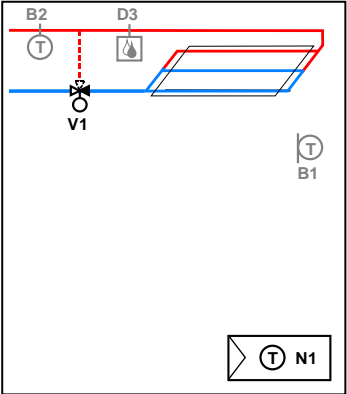
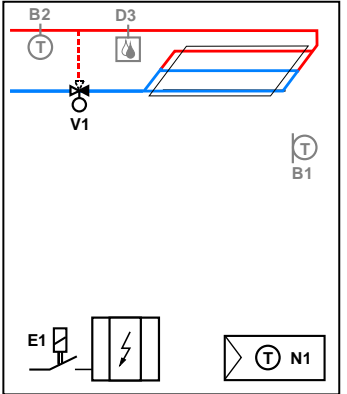
V1 Heating or heating/cooling valve actuator
 V2 Cooling valve actuator
 E1 Electrical heater

M1 3-speed or single-speed fan
 B1 Return air temperature sensor or external room temperature sensor (optional)
 B2 Changeover sensor (optional)

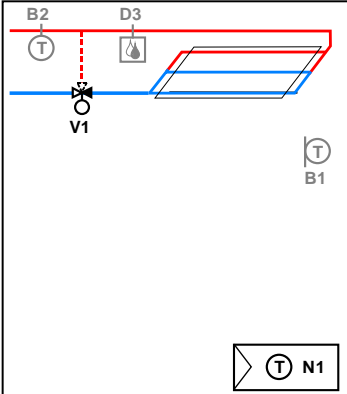
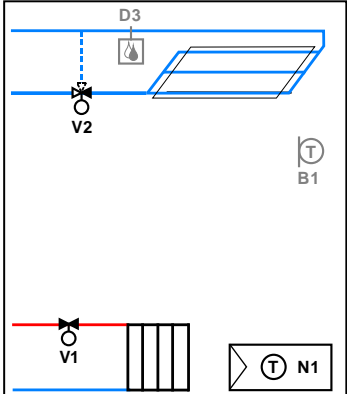
Application and output signal, DIP switches, diagram						
<ul style="list-style-type: none"> Chilled / heated ceiling ON/OFF (heating or cooling) Chilled / heated ceiling modulating, DC 0...10 V (heating or cooling) 	 	RDF300... RDF400... RDF600... RDF340	 	<ul style="list-style-type: none"> Chilled / heated ceiling ON/OFF (heating or cooling) with electrical heater Chilled / heated ceiling modulating, DC 0...10 V (heating or cooling) with electrical heater 	RDF300... RDF400... RDF600... RDF340	
	3191S11		3191S12			
<ul style="list-style-type: none"> Chilled / heated ceiling modulating, 3-position (heating or cooling) 		RDF300... RDF400... RDF600...		<ul style="list-style-type: none"> Chilled ceiling and radiator ON/OFF (heating and cooling) 	 	RDF300... RDF400... RDF600... RDF340
	3191S11		3191S13			

V1 Heating or heating / cooling valve actuator

V2 Cooling valve actuator

E1 Electrical heater





B1 Return air temperature sensor or external room temperature sensor (optional)

B2 Changeover sensor (optional)

D3 Dewpoint sensor

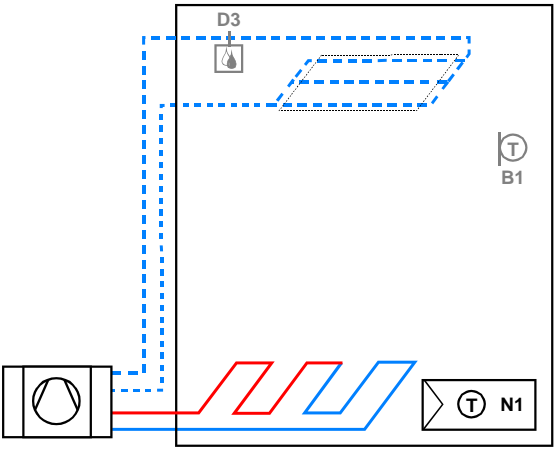
Applications for heat pump systems

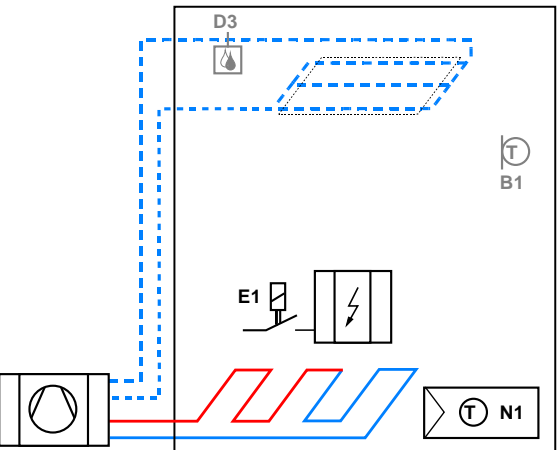
Application and output signal, DIP switches, diagram

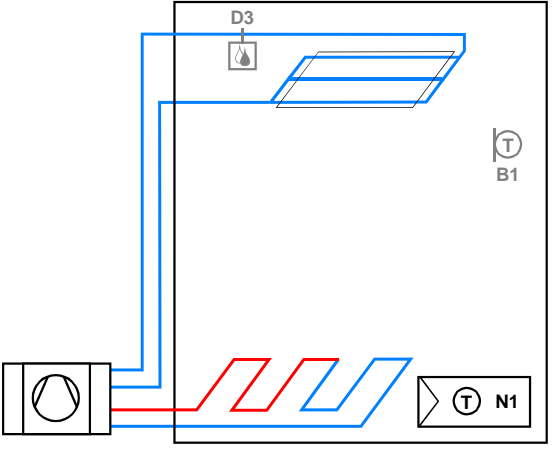
<ul style="list-style-type: none"> • 1-stage compressor ON/OFF (heating or cooling)  RDF300... RDF400... RDF600...  <p style="text-align: right;">3181S31</p>	<ul style="list-style-type: none"> • 1-stage compressor ON/OFF (heating or cooling) with electrical heater  RDF300... RDF400... RDF600...  <p style="text-align: right;">3181S32</p>
<ul style="list-style-type: none"> • 1-stage compressor ON/OFF (heating and cooling)  RDF300... RDF400... RDF600...  <p style="text-align: right;">3181S35</p>	

N1 Thermostat
Terminal Y10/Y11: Heating (H&C) or Heating/Cooling
Terminal Y20/Y21: Cooling (H&C)

B1 Return air temperature sensor or external room temperature sensor (optional)
D3 Dewpoint sensor

Type summary

Product number	Stock number	Features							
		Operating Voltage	Control outputs			Time program	Backlit LCD	Infrared receiver ¹⁾	Suitable conduit box ²⁾
			on/off	3pt	DC 0..10V				
RDF300	RDF300	AC 230 V	✓	✓					square
RDF300.02	RDF300.02	AC 230 V	✓	✓			✓		square
RDF400.01	RDF400.01	AC 230 V	✓	✓		✓	✓	✓	square
RDF340	RDF340	AC 24 V			✓				square
RDF600	S55770-T291	AC 230 V	✓	✓			✓		round
RDF600T	S55770-T292	AC 230 V	✓	✓		✓	✓	✓	round

1) Infrared remote control is to be ordered as separate item









2) Square conduit box e.g. ARG71.

Round conduit box min 60 mm diameter and min 40 mm depth

Ordering







- When ordering, indicate both product number / SSN number and name:
E.g. **RDF600 / S55770-T291 room thermostat**
- Order the **IRA211 (S55770-T166)** infrared remote control separately (for RDF400../RDF600...).
- Order valve actuators separately.

Equipment combinations

Designation		Product no.	Data Sheet ¹⁾
Cable temperature sensor or changeover sensor, cable length 2.5 m NTC (3 kΩ at 25 °C)		QAH11.1	1840
Room temperature sensor NTC (3 kΩ at 25 °C)		QAA32	1747
Cable temperature sensor, cable length 4 m NTC (3 kΩ at 25 °C)		QAP1030/UFH	1854
Condensation / Dew point monitor		QXA2601 / QXA2602 / QXA2603 / AQX2604	3302
Electromotoric ON/OFF actuator		SFA21...	4863
Electromotoric ON/OFF valve and actuator (only available in AP, UAE, SA and IN)		MVI.../MXI...	4867
Zone valve actuators (only available in AP, UAE, SA and IN)		SUA...	4832
Thermal actuator (for radiator valve)		STA23...	4884
Thermal actuator (for small valves 2.5 mm)		STP23...	4884



On / off actuators

3-position actuators

Designation		Product no.	Data Sheet ^{*)}
Electrical actuator, 3-position (for radiator valve)		SSA31...	4893
Electrical actuator, 3-position (for small valve 2.5 mm)		SSP31...	4864
Electrical actuator, 3-position (for small valve 5.5 mm)		SSB31...	4891
Electrical actuator, 3-position (for 2- and 3-port valves / V...P45)		SSC31...	4895
Electrical actuator, 3-position (for small valve 5.5 mm)		SSD31...	4861
Electromotoric actuator, 3-position (for small valves 5.5 mm)		SQS35...	4573

*) The documents can be downloaded from <http://siemens.com/bt/download>.

Accessories

Designation		Product no.	Data Sheet
Changeover mounting kit (50 pcs/package)		ARG86.3	N3009
Plastic mounting spacer for flush-mounted thermostats RDF3.. RDF400... for increasing the headroom in the conduit box by 10 mm		ARG70.3	N3009
Conduit box for flush-mounted thermostat RDF3.. RDF400...		ARG71 / S55770-T137	N3009

The thermostat consists of 2 parts:

- Front panel accommodating the electronics, operating elements and built-in room temperature sensor.
- Mounting base with the power electronics.

The rear of the mounting base contains the screw terminals Slide the front panel in the mounting base and snap on.

Operation and settings
RDF300.../RDF340...
RDF600



1. Operating mode selector / Protection
2. Change fan operation
3. Adjust setpoint and control parameters

RDF400...
RDF600T

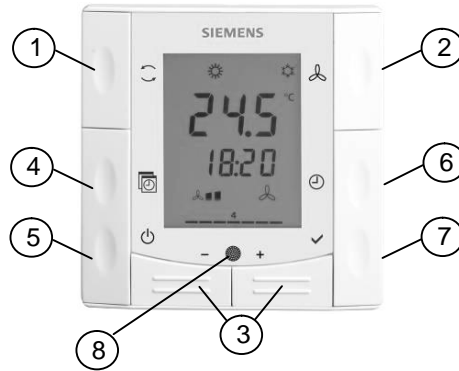

1. Change operating mode selector
2. Change fan operation
3. Adjust setpoint, control parameters and time of day
4. Auto Timer program
5. Protection
6. Set time of day and weekday
7. Confirm
8. Infrared receiver

Display

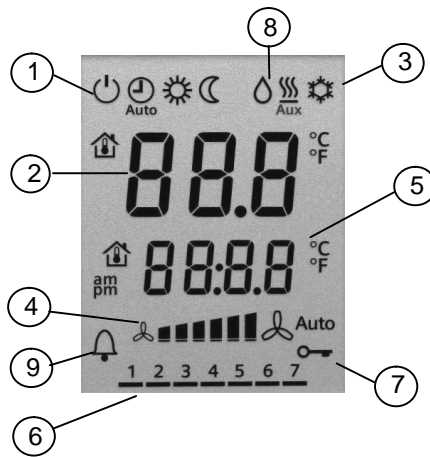

1. Operating mode
 - ⏻ Protection
 - 🕒 Auto Timer mode *
 - ☀️ Comfort
 - 🌙 Economy

2. Display room temperature, setpoints and control parameters.
 - 🏠 Symbol used to display the current room temperature
 3. Heating/cooling mode
 - ⚙️ Cooling mode
 - 🔥 Heating mode,
 - ⚡ Aux Electrical heater active
 4. Fan mode
 - 🌀 Auto Auto fan active
 - 🌀 Fan speed low, medium, high
 5. Additional user information (RDF3xx) or current time of day (RDF400 / RDF600T)
 6. Weekday 1..7 (1 = Monday/7 = Sunday)*
 7. Key lock active
 8. Condensation in room (dewpoint sensor active)
 9. Indicate fault or reminder
- * only on RDF400... / RDF600T

Mounting and installation

Mount the room thermostat on the conduit box. Do not mount on a wall in niches or bookshelves, behind curtains, above or near heat sources, or exposed to direct solar radiation. Mount about 1.5 m above the floor.

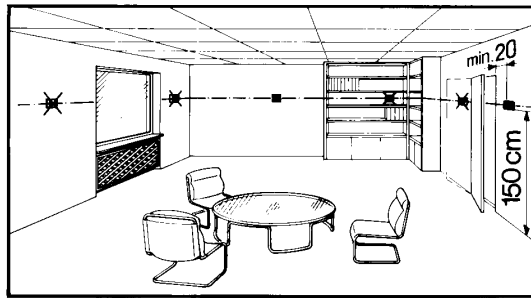

Mounting / dismounting



- Devices must be mounted on clean, dry indoor place without direct airflow from a heating / cooling device, and not be exposed to dripping or splashing
- RDF3... / RDF400... : In case of limited space in the conduit box use the mounting bracket ARG70.3 to increase the headroom by 10mm
- Before removing the front cover, disconnect the power supply.

Wiring



See the mounting instructions enclosed with the thermostat:

M3076... for RDF3..., RDF4... ; M3063 for RDF600... .

- Wiring, protection and earthing must be installed in compliance with local regulations.



Warning!

No internal line protection for supply lines to external consumers (Q1, Q2, Q3, Yxx)

Risk of fire and injury due to short-circuits!

- Adapt the line diameters as per local regulations to the rated value of the installed overcurrent protection device.
- Use only valve actuators rated for AC 230 V on RDF300... / RDF400... / RDF600..
- The AC 230 V mains supply line must have an external fuse or circuit breaker with a rated current of no more than 10 A.
- Isolate the cables of SELV inputs X1-M/X2-M if the conduit box carries AC 230 V mains voltage.
- Inputs X1-M or X2-M of different units (e.g. summer/winter switch) may be connected in parallel with an external switch. Consider overall maximum contact sensing current for switch rating.
- No metal conduits
- No cables provided with a metal sheath
- Disconnect from supply before opening the cover



Commissioning

Set the thermostat application via the DIP switches before snapping the front panel on the mounting base.

After power is applied, the thermostat carries out a reset during which all LCD segments flash indicating that the reset was correct. After the reset, which takes about 3 seconds, the thermostat is ready for commissioning by qualified HVAC staff.

The control parameters of the thermostat can be set to ensure optimum performance of the entire system (see basic documentation P3076).

Note After powerfail the thermostat restarts in the same mode as before.

Control sequence

- The control sequence may need to be set via parameter P01 depending on the application. The factory setting for the 2-pipe application is "Cooling only"; and "Heating and Cooling" for the 4-pipe application.

Compressor-based application 

- When the thermostat is used with a compressor, the minimum output on-time (parameter P48) and off-time (parameter P49) for Y11/Y21 must be adjusted to avoid damaging the compressor and shortening its life.

Calibrate sensor

- Recalibrate the temperature sensor if the room temperature displayed on the thermostat does not match the room temperature measured (after min. 1 hour of operation). To do this, change parameter P05.

Setpoint and range limitation

We recommend to review the setpoints and setpoint ranges (parameters P08...P12) and change them as needed to achieve maximum comfort and save energy.

Disposal



The devices are considered electronics devices for disposal in term of European Directive 2012/19/EU and may not be disposed of as domestic waste.

- Dispose of the device via the channels provided for this purpose
- Comply with all local and currently applicable laws and regulations.

Technical data

 Power supply

Rated voltage	RDF300... /400... / 600... RDF340...	AC 230 V SELV AC 24 V \pm 20 % or AC 24 V class 2 (US)
Frequency		50/60 Hz
Power consumption	RDF300... / RDF400.. RDF340... RDF600...	Max. 8 VA Max. 3.5 VA / 0.8 W
External supply line protection (EU)		Circuit breaker max. 10 A Characteristic B, C, D according to EN 60898 or Power source with current limitation of max. 10 A



No internal fuse

External preliminary protection with max. C 10 A circuit breaker in the supply line required under all circumstances

Outputs

Fan control Q1, Q2, Q3-N	AC 230 V
Rating	5 mA...5(2) A
Control output Y11-N/Y21-N (N.O.)	AC 230 V
Rating	5 mA...5(2) A
Control output Y10-G0/Y20-G0	SELV DC 0...10 V
Resolution	39 mV
Current	Max. \pm 1 mA
Max. total load current through terminal "L" (Qx + Yxx)	Max. 7 A

Inputs

Multifunctional input X1-M/X2-M	
Temperature sensor input:	
Type	NTC (3 k Ω at 25 °C)
Temperature range	0...49 °C
Cable length	Max. 80 m
Digital input:	
Operating action	Selectable (N.O./N.C.)
Contact sensing	SELV DC 0...5 V/max. 5 mA
Parallel connection of several thermostats for one switch	Max. 20 thermostats per switch
Insulation against mains voltage (SELV)	4 kV, reinforced insulation

	Function input:		
	External temperature sensor, heating/cooling changeover sensor, operating mode switchover contact, dewpoint monitor contact, enable electrical heater contact, alarm contact	Selectable X1: P38 X2: P40	
Operational data	Switching differential, adjustable		
	Heating mode Cooling mode	(P30) (P31)	2 K (0.5...6K) 1 K (0.5...6K)
	Setpoint setting and range		
	☀ Comfort	(P08)	21°C (5...40 °C)
	☾ Economy	(P11-P12)	15°C/30°C (OFF, 5...40 °C)
	⏸ Protection	(P65-P66)	8°C/OFF (OFF, 5...40 °C)
	Multifunctional input X1/X2		Selectable 0...6
	Input X1		3: (P38) operating mode switchover
	Input X2		2: (P40) heating/cooling changeover sensor
	Built-in room temperature sensor		
	Measuring range		0...49 °C
	Accuracy at 25 °C		< ± 0.5 K
	Temperature calibration range		± 3.0 K
	Settings and display resolution		
	Setpoints		0.5 °C
	Current temperature value displayed		0.5 °C
Environmental conditions	Operation		As per IEC 60721-3-3
	Climatic conditions		Class 3K5
	Temperature		0...50 °C
	Humidity		<95% r.h.
	Transport		As per IEC 60721-3-2
	Climatic conditions		Class 2K3
	Temperature		-25...60 °C
	Humidity		<95% r.h.
	Mechanical conditions		Class 2M2
	Storage		As per IEC 60721-3-1
	Climatic conditions		Class 1K3
	Temperature		-25...60 °C
	Humidity		<95% r.h.
Standards and directives	EU Conformity (CE)		CE1T3076_1 ^{*)} CE1T3076xx_2 ^{*)} CE1T3076xx_3 ^{*)}
	RCM Conformity		CE1T3076_1en_C1 ^{*)} CE1T3076xx_2en_C1 ^{*)} CE1T3076xx_3en_C1 ^{*)}
	Degree of protection of housing		IP 30 to EN 60529
	Protective class		II as per EN 60730-1
	Pollution class		Normal
Environmental compatibility	The product environmental declarations CE1E3076_1, CE1E3076_2, CE1E3076_3 ^{*)} contain data on environmentally compatible product design and assessments (RoHS compliance, materials composition, packaging, environmental benefit, disposal).		
General	Connection terminals		Solid wires or prepared stranded wires 1 x 0.4...1.5 mm ²
	Housing front color		RAL 9003 white
	Weight	RDF3..., RDF4... RDF600...	0.220 kg 0.150 kg

*) The documents can be downloaded from <http://siemens.com/bt/download>.

Connection terminals

RDF300.../RDF400...
RDF600...

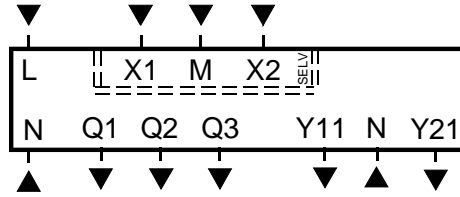

- L, N Operating voltage AC 230 V
- Q1 Control output "Fan speed 1 AC 230 V"
- Q2 Control output "Fan speed 2 AC 230 V"
- Q3 Control output "Fan speed 3 AC 230 V"
- Y11, Y21 Control output "Valve" AC 230 V (N.O., for normally closed valves), output for compressor or output for electrical heater
- X1, X2 Multifunctional input for temperature sensor (e.g. QAH11.1) or potential-free switch
- M Measuring neutral for sensor and switch

RDF340...

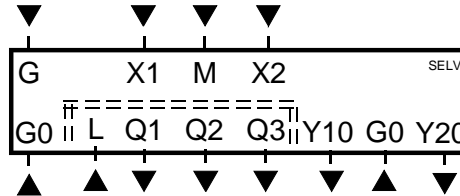

- G, G0 Operating voltage thermostat AC 24 V
- L Operating voltage for fan AC 230 V
- Q1 Control output "Fan speed 1 AC 230 V"
- Q2 Control output "Fan speed 2 AC 230 V"
- Q3 Control output "Fan speed 3 AC 230 V"
- Y10, Y20 Control output for DC 0...10 V actuator
- X1, X2 Multifunctional input for temperature sensor (e.g. QAH11.1) or switch
- M Measuring neutral for sensor and switch

Connection diagrams

RDF300..., RDF400..., RDF600...

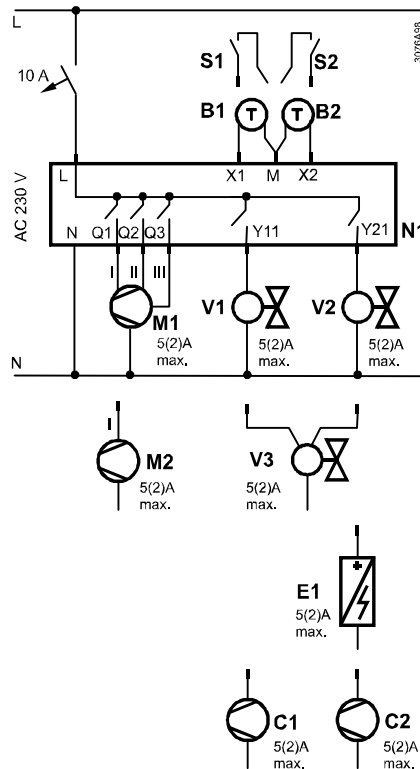

- N1 Room thermostat RDF300... / RDF400... / RDF600
- M1 3-speed fan
- M2 1-speed fan
- V1...V3 Valve actuator
- E1 Electrical heater
- S1, S2 Switch (keycard, window contact, etc.)
- B1, B2 Temperature sensor (return air temperature, external room temperature, changeover sensor, etc.)
- C1, C2 Compressor

RDF340...

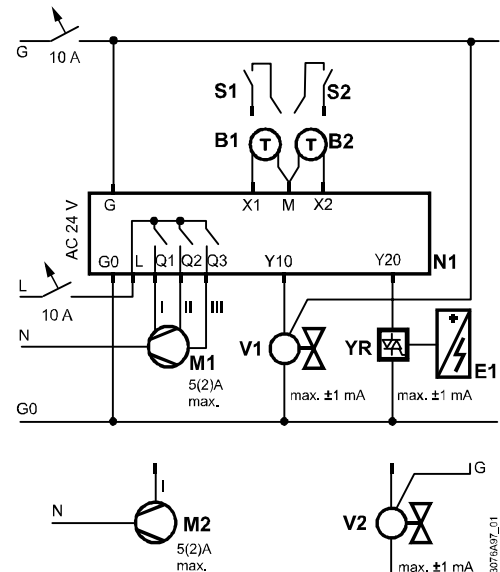

⚠ For US installations use Class 2 rated power supplies. For other installations use circuit breakers with rated current of no more than 10 A.

- N1 Room thermostat RDF340...
- M1 3-speed fan
- M2 1-speed fan
- V1, V2 Valve actuator
- YR DC 0...10 signal converter/current valve
- E1 Electrical heater
- S1, S2 Switch (keycard, window contact, etc.)
- B1, B2 Temperature sensor (return air temperature, external room temperature, changeover sensor, etc.)

Dimensions

Dimensions in mm

RDF3... RDF400...

RDF600...

